

## Draufsichten s500p

	Seite
s500peds2	1+2
s500pds2	3+4
s500pds2 + td	5+6
s500pds2 + td kurz	7+8
s500pds2f	9+10

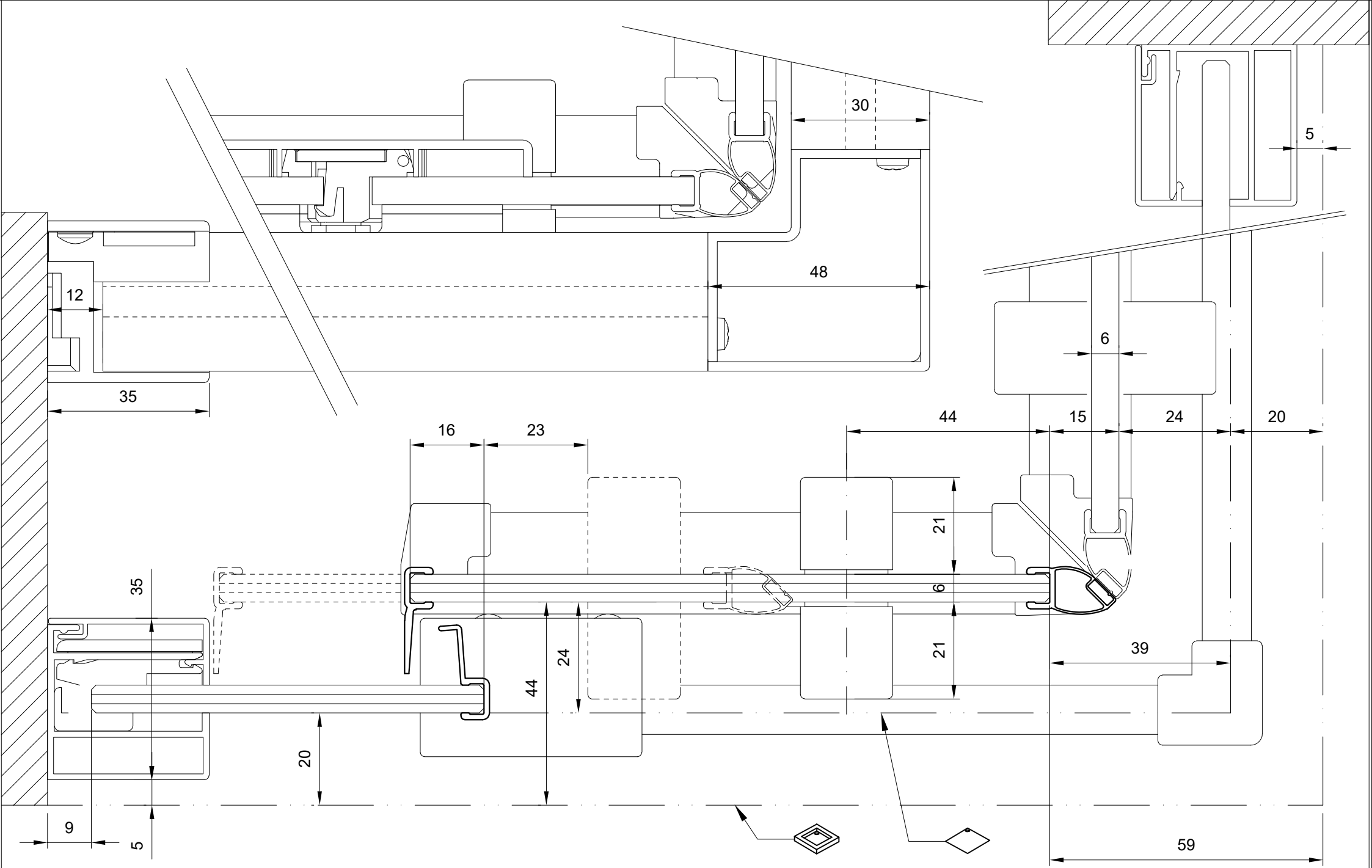



# S500peds2 links

	Name / Nom	Datum / Date
Erstellt / Vu	chh	25.08.2020
Geprüft / Approuvé	wet / chh	07.09.2020

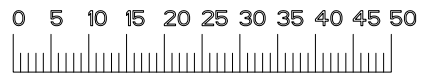
A 1:1



-  Auf Wanne / Sur bac
-  Bodeneben / A fleur de sol



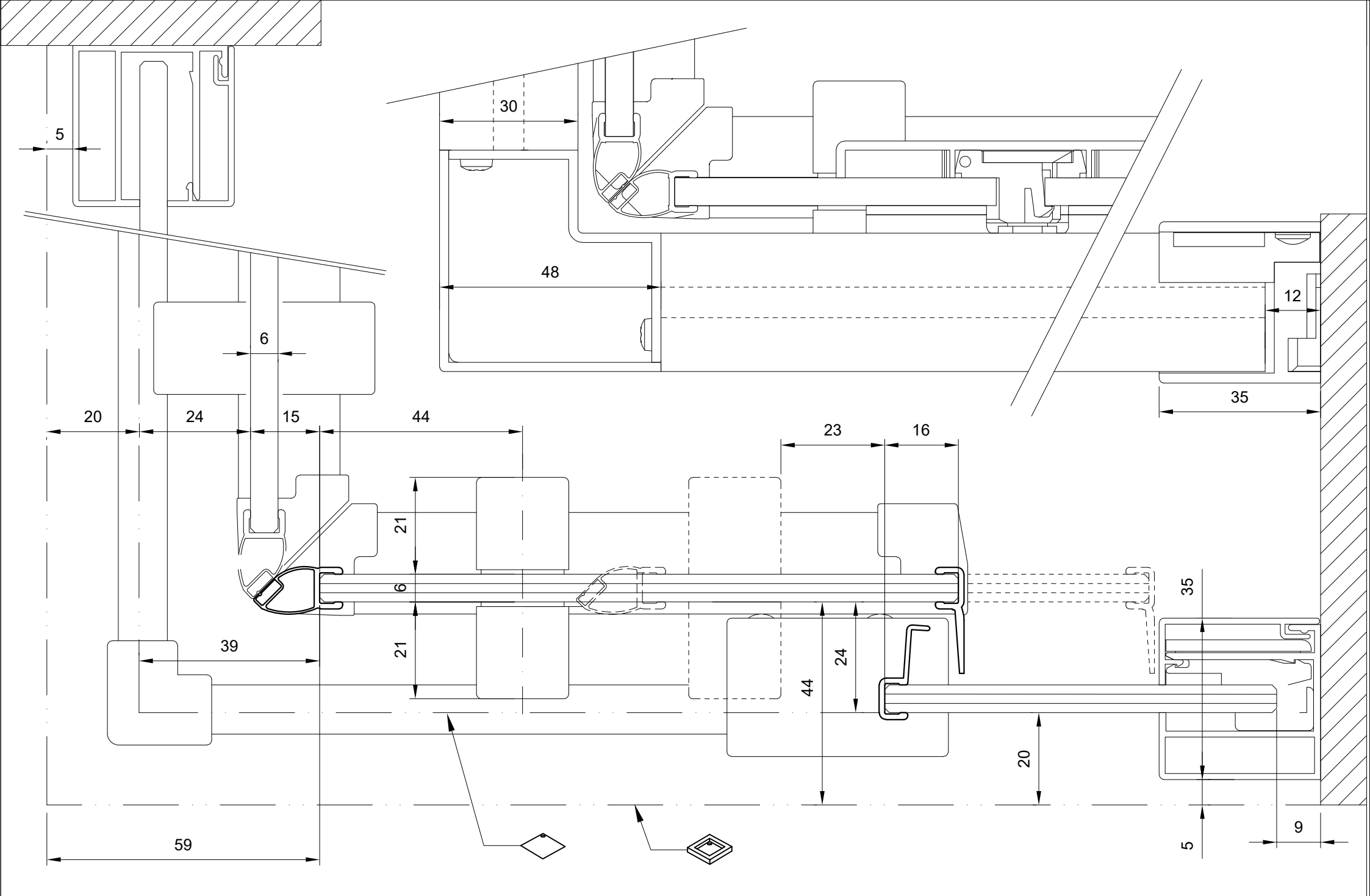



# S500peds2 rechts

Erstellt / Vu	Name / Nom	Datum / Date
Geprüft / Approuvé	chh	25.08.2020
	wet / chh	07.09.2020

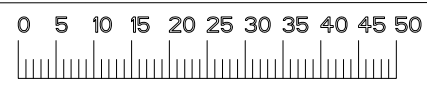
A 1:1



-  Auf Wanne / Sur bac
-  Bodeneben / A fleur de sol



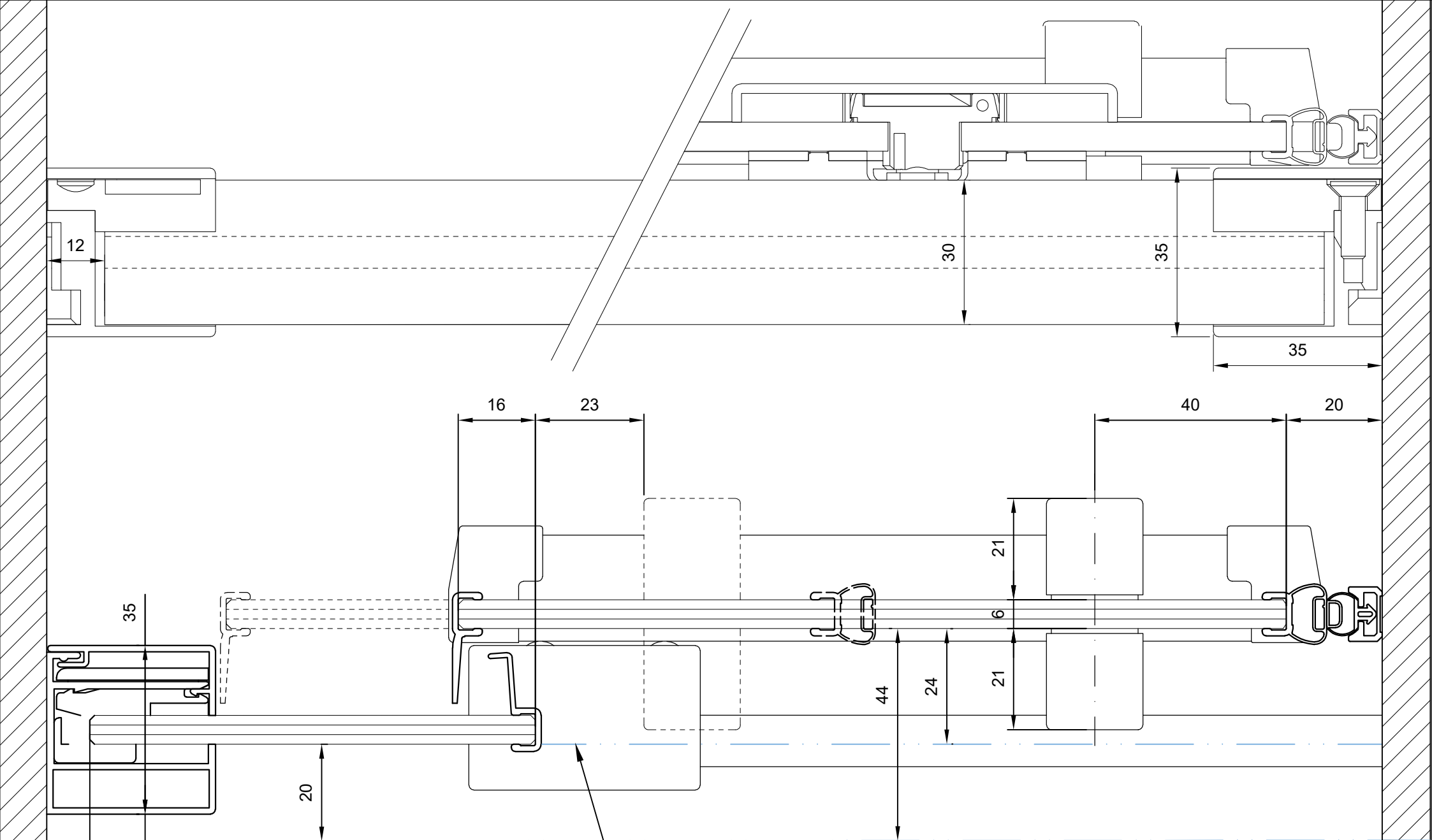



# S500pds2 links

Erstellt / Vu	Name / Nom	Datum / Date
Geprüft / Approuvé	chh	25.08.2020
	wet / chh	07.09.2020

A 1:1



 Auf Wanne / Sur bac  
 Bodeneben / A fleur de sol



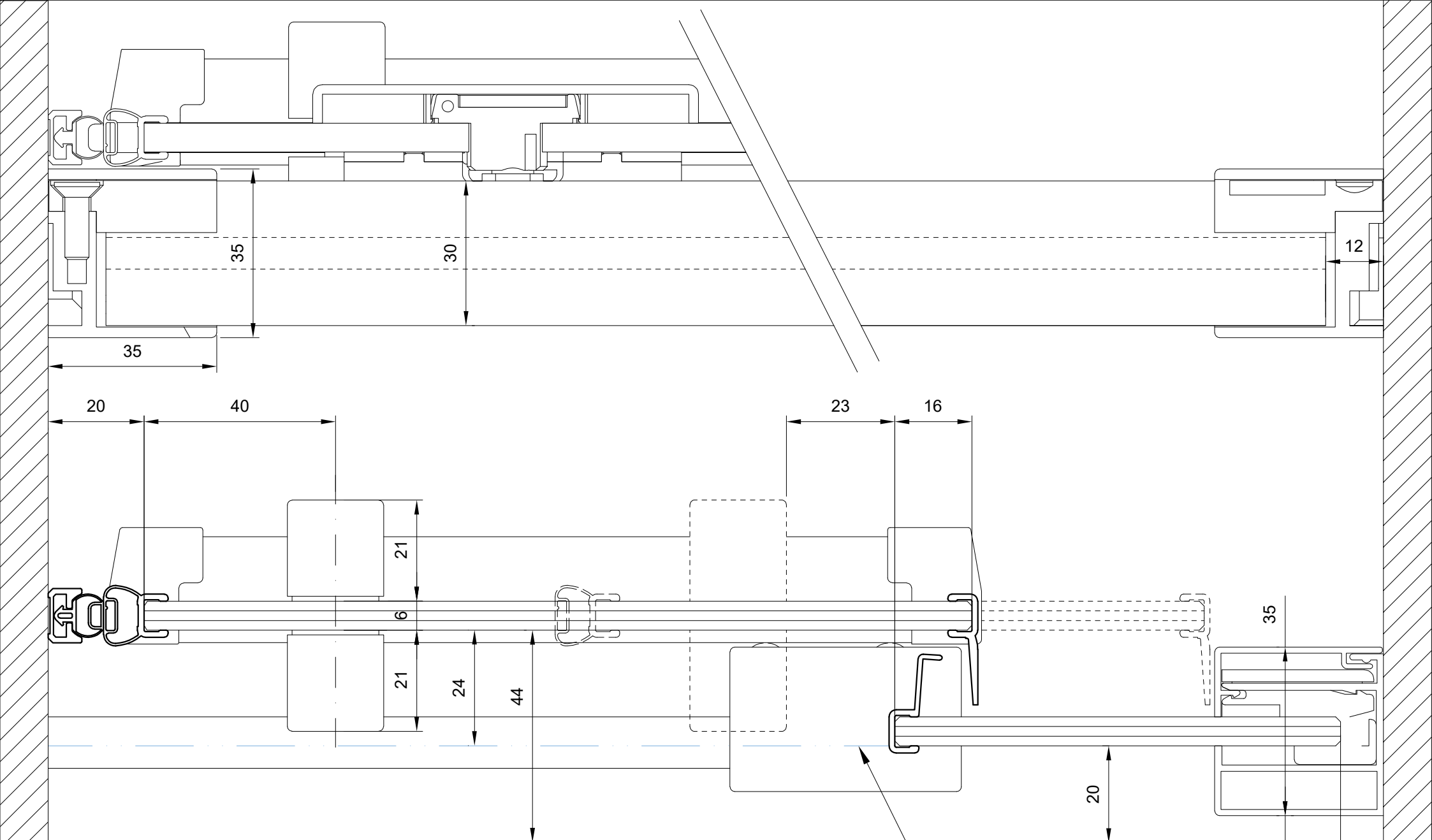

# S500pds2 rechts

Erstellt / Vu	Name / Nom	Datum / Date
chh	chh	25.08.2020
Geprüft / Approuvé	wet / chh	07.09.2020

A 1:1

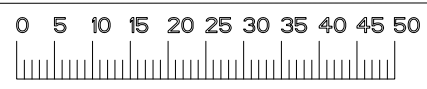

- Auf Wanne / Sur bac
- Bodeneben / A fleur de sol



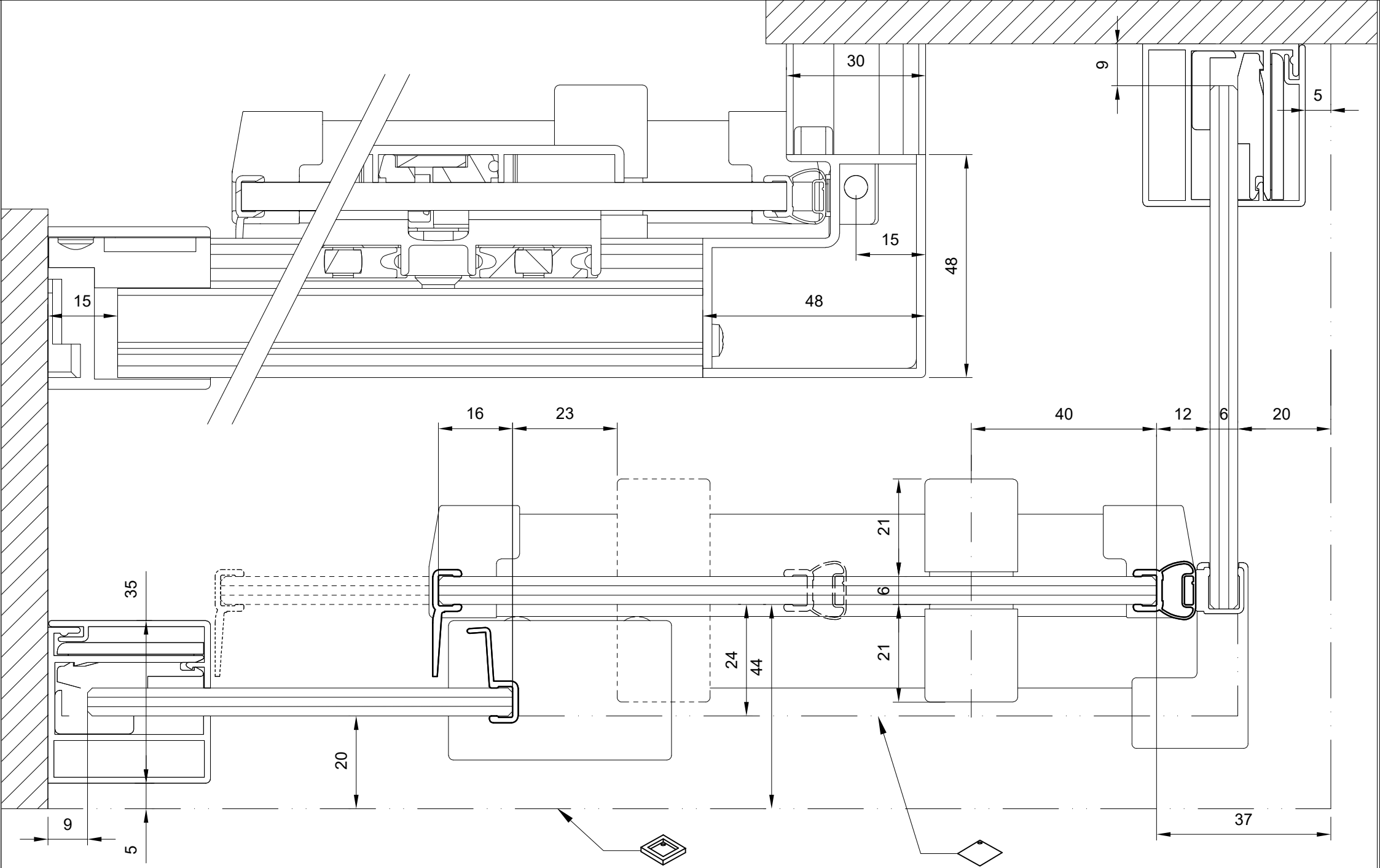

# S500pds2+td links

Erstellt / Vu	Name / Nom	Datum / Date
Geprüft / Approuvé	chh	25.08.2020
	wet / chh	07.09.2020

A 1:1

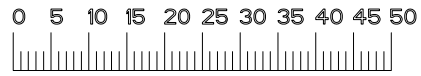

- Auf Wanne / Sur bac
- Bodeneben / A fleur de sol



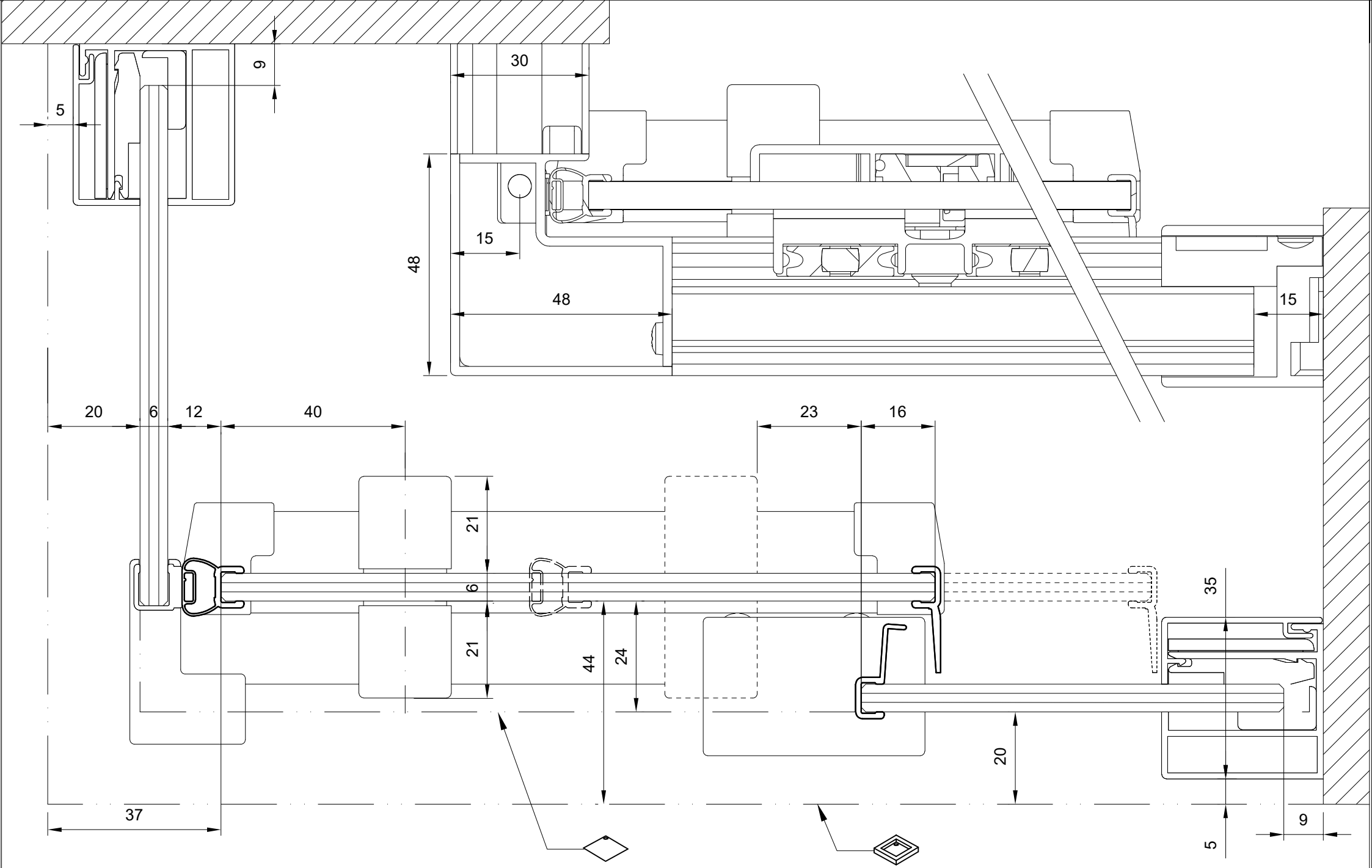



# S500pds2+td rechts

Erstellt / Vu	chh	Datum / Date	25.08.2020
Geprüft / Approuvé	wet / chh	Datum / Date	07.09.2020

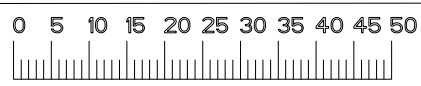
A 1:1



-  Auf Wanne / Sur bac
-  Bodeneben / A fleur de sol



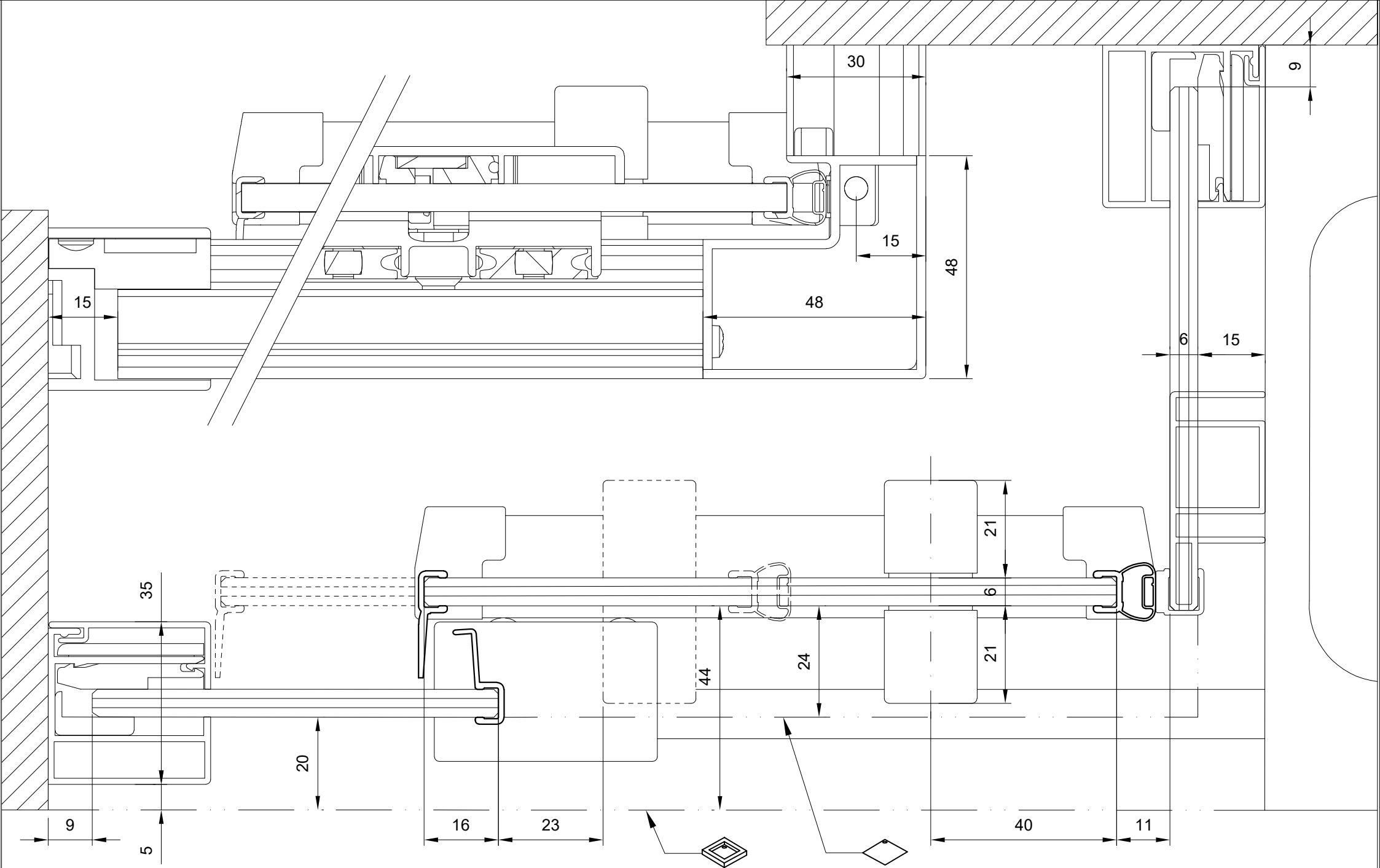



**S500pds2+td kurz links**

	Name / Nom	Datum / Date
Erstellt / Vu	chh	25.08.2020
Geprüft / Approuvé	wet / chh	07.09.2020

**A 1:1**



 Auf Wanne / Sur bac  
 Bodeneben / A fleur de sol





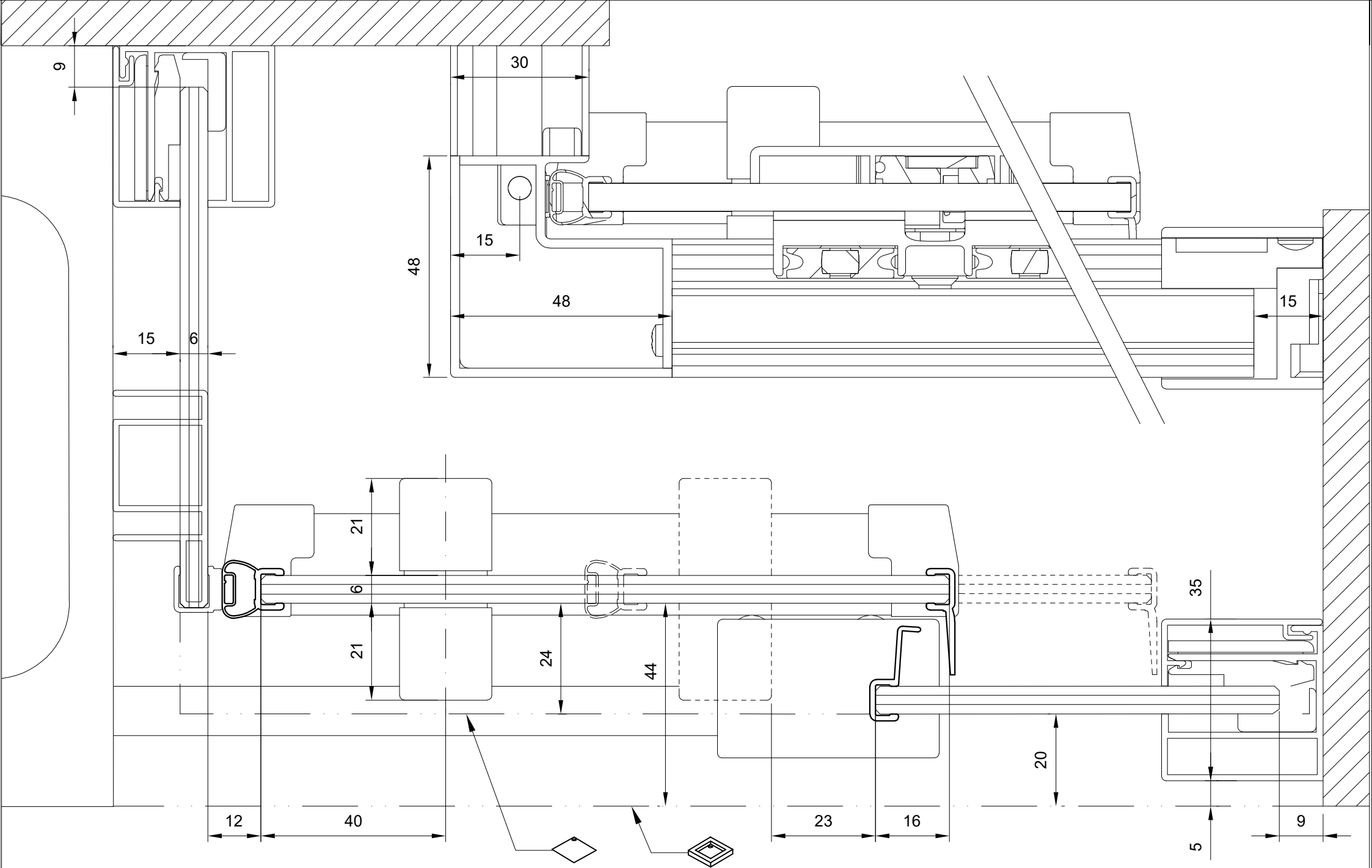

**S500pds2+td kurz rechts**

Erstellt / Vu	Name / Nom	Datum / Date
Geprüft / Approuvé	chh	25.08.2020
	wet / chh	07.09.2020

A 1:1

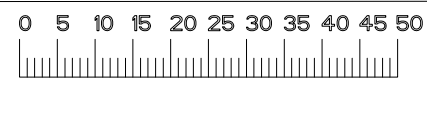

Auf Wanne / Sur bac

Bodeneben / A fleur de sol



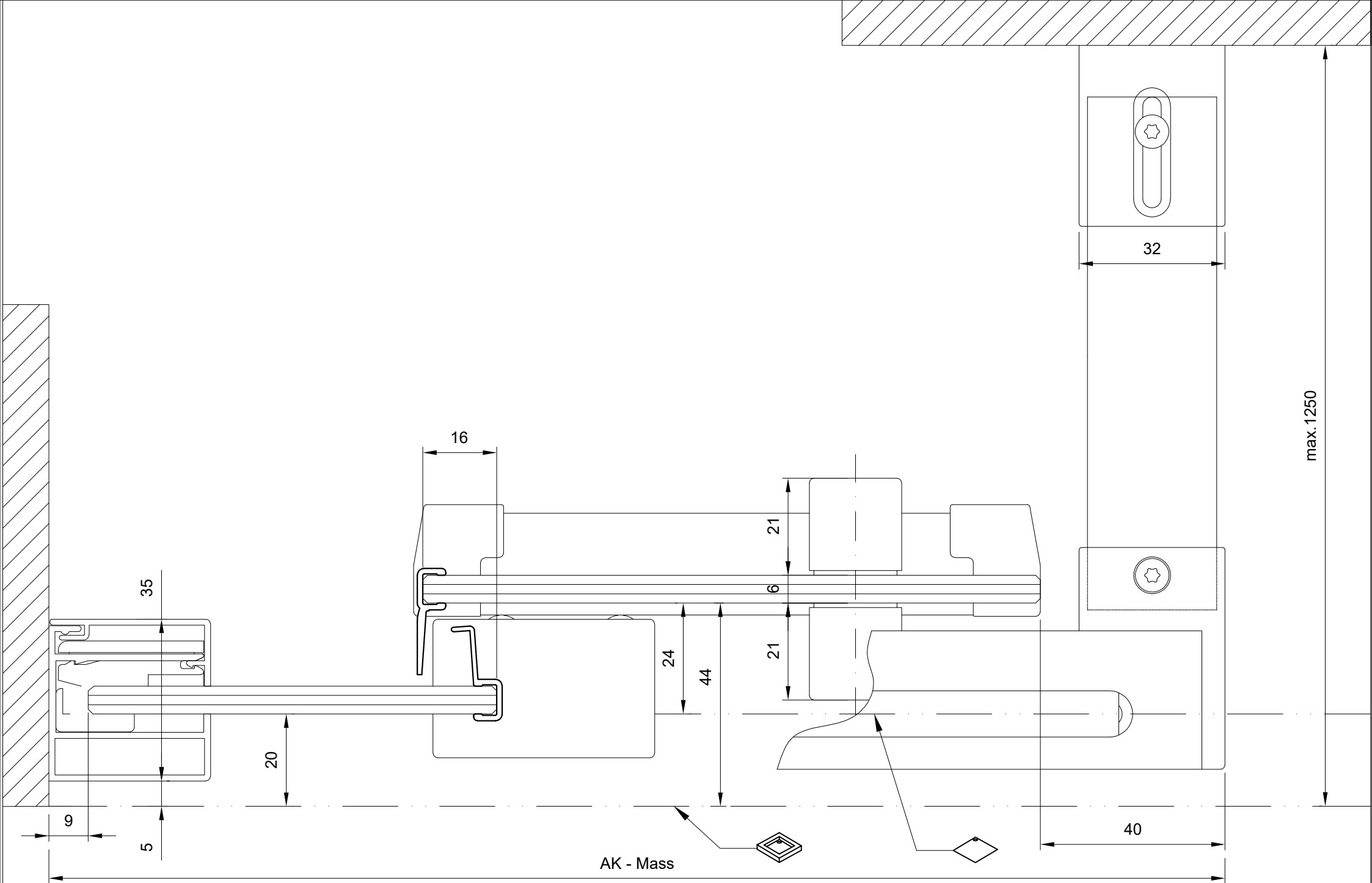



# S500pds2F links

	Name / Nom	Datum / Date
Erstellt / Vu	chh	25.08.2020
Geprüft / Approuvé	wet / chh	07.09.2020

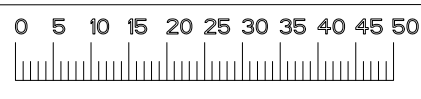
A 1:1



-  Auf Wanne / Sur bac
-  Bodeneben / A fleur de sol



max. 1250

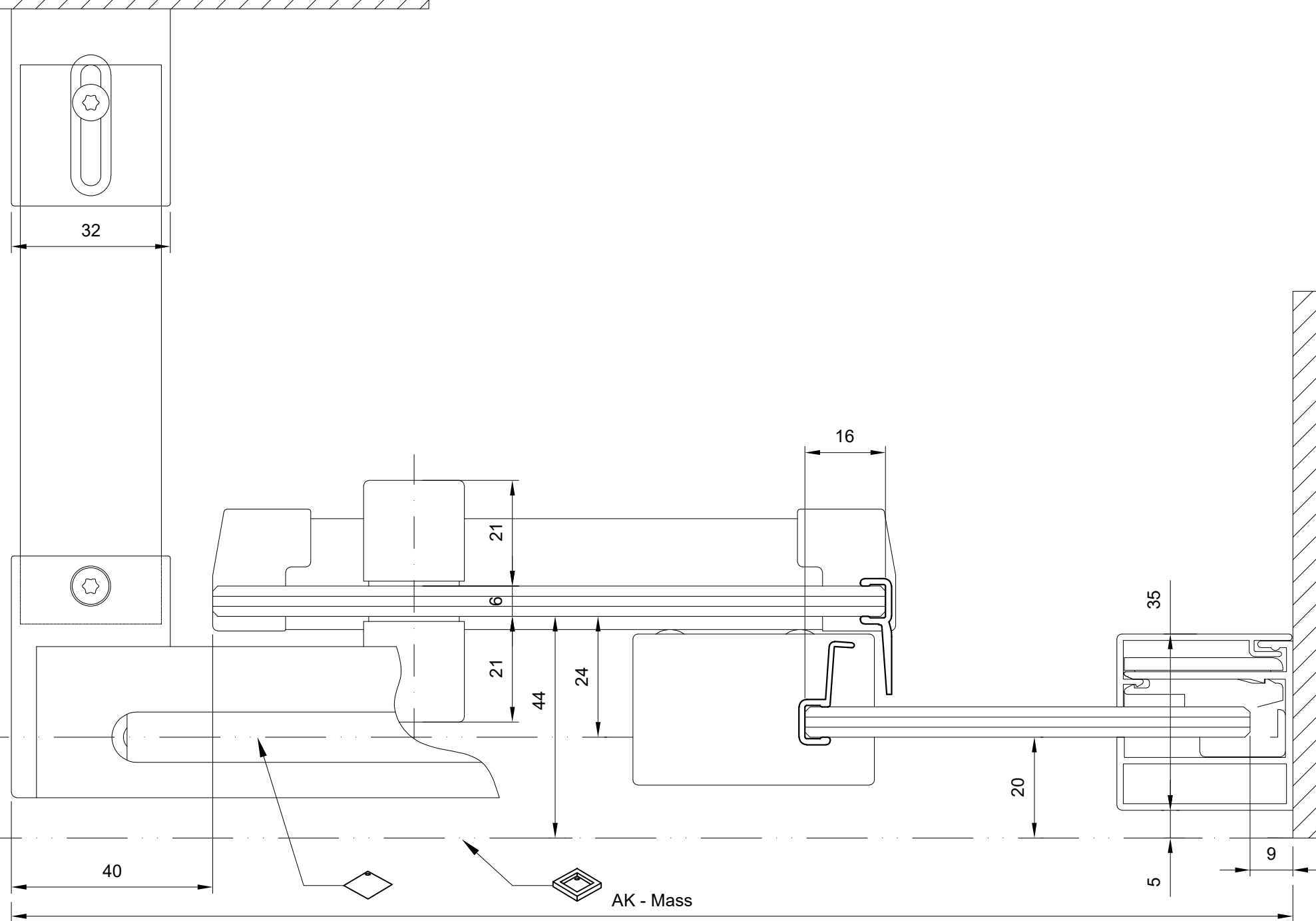

# S500pds2F rechts

Erstellt / Vu	Name / Nom	Datum / Date
chh		25.08.2020
Geprüft / Approuvé	wet / chh	07.09.2020

A 1:1



- Auf Wanne / Sur bac
- Bodeneben / A fleur de sol

